

CAPACITY GRID UNICO BALLROOMS

ROOM	DIMENTIONS FT	DIMENTIONS MTS	SQ FT	M2	CEILING FT	CEILING MTS	THEATRE	CONFERENCE	U-SHAPE	BANQUET	COCKTAIL	CLASSROOM
SALON CENTRAL	139,34 X 83,33	42.47 X 25.40	11603	1078	20,34	6.2	1104	N/A	N/A	840	1104	768
CENTRAL 1, 2, 3	46,33 X 83.33	14.12 X 25.40	3853,4	358.6	20,34	6.2	368	N/A	N/A	280	368	256
SALONES (1-6)	115,78 X 20,01	35.29 X 6.10	2317,15	215.27	12,14	3.7	220	N/A	N/A	150	220	117
SALONES 1,2,5	15,91 X 20,01	4.85 X 6.10	317,54	29.5	12,14	3.7	30	16	16	20	30	18
SALONES 3,4	24,05 X 20,01	7.33 X 6.10	481,15	44.7	12,14	3.7	45	28	24	30	45	27
SALÓN 6	19,78 X 20,01	6.03 X 6.10	395,9	36.78	12,14	3.7	40	24	20	20	40	24
SALONES 7, 8	15,75 X 30,18	4.8 X 9.2	473,61	44	12,14	3.7	48	28	28	30	48	30
LIBRERÍA 1, 2	15,75 X 30,18	4.8 X 9.2	473,61	44	12,14	3.7	N/A	N/A	20	N/A	N/A	N/A

CAPACITY GRID UNICO “SALONES CENTRAL” BALLROOMS

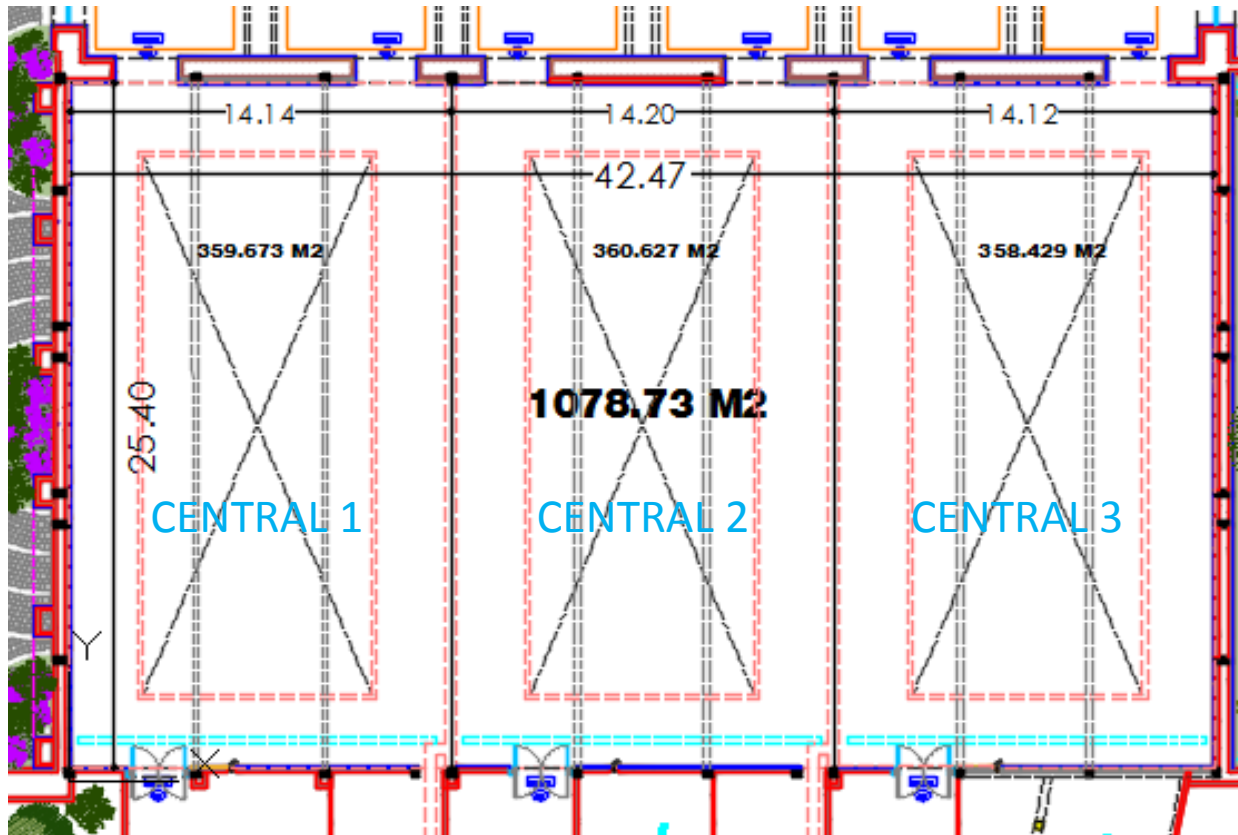

ROOM	DIMINTIONS FT	DIMINTIONS MTS	SQ. FT	M2	CEILING FT	CEILING MTS	THEATRE	CONFERENCE	U-SHAPE	BANQUET	COCKTAIL	CLASSROOM
SALON CENTRAL	139,34 X 83,33	42.47 X 25.40	11603	1078	20,34	6.2	1104	N/A	N/A	840	1104	768
CENTRAL 1, 2, 3	46,33 X 83.33	14.12 X 25.40	3853,4	358.6	20,34	6.2	368	N/A	N/A	280	368	256

CAPACITY GRID UNICO
"SALONES CENTRAL" 1-3
MAX. THEATRE

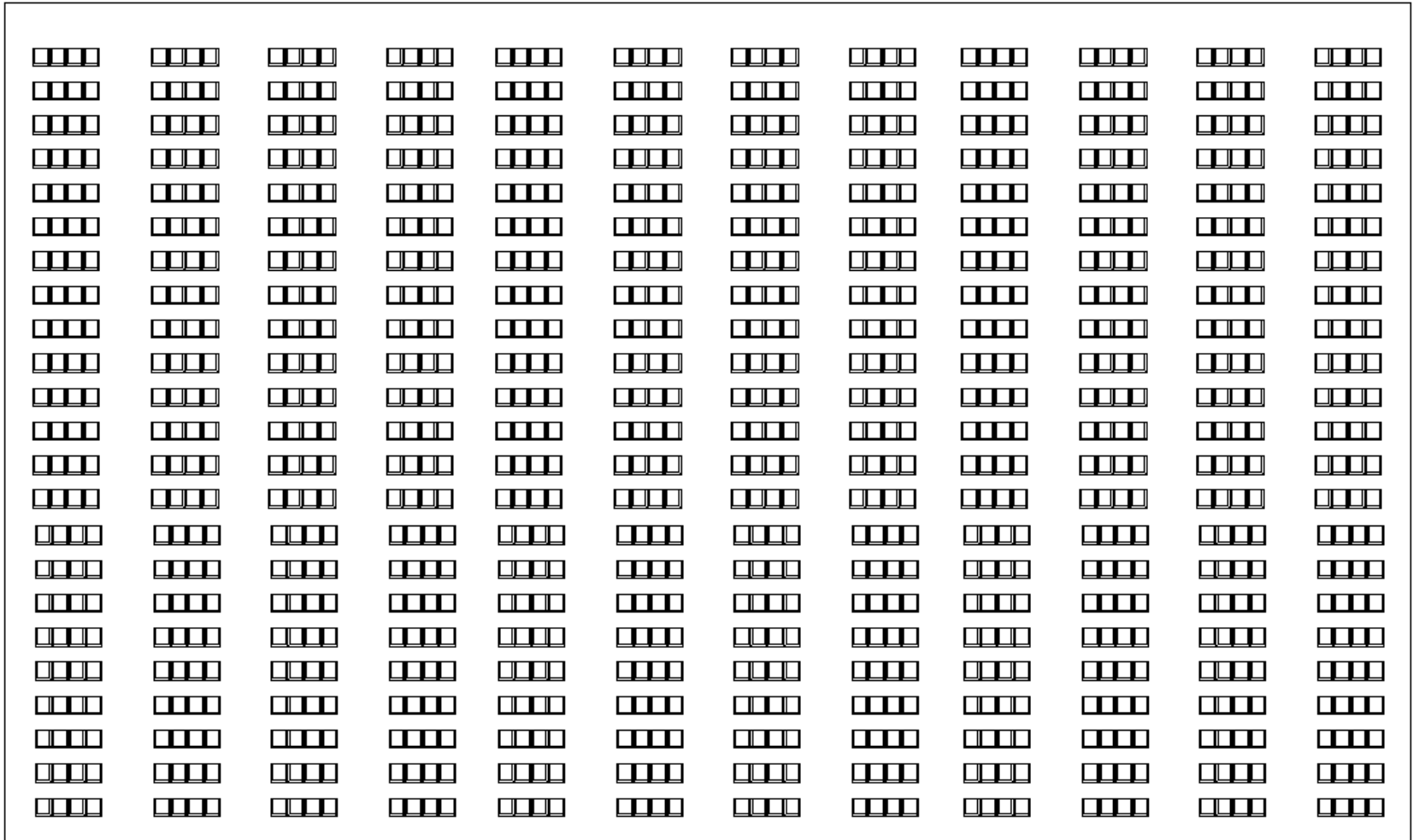

CAPACITY GRID UNICO

“SALONES CENTRAL” 1

MAX. CLASSROOM

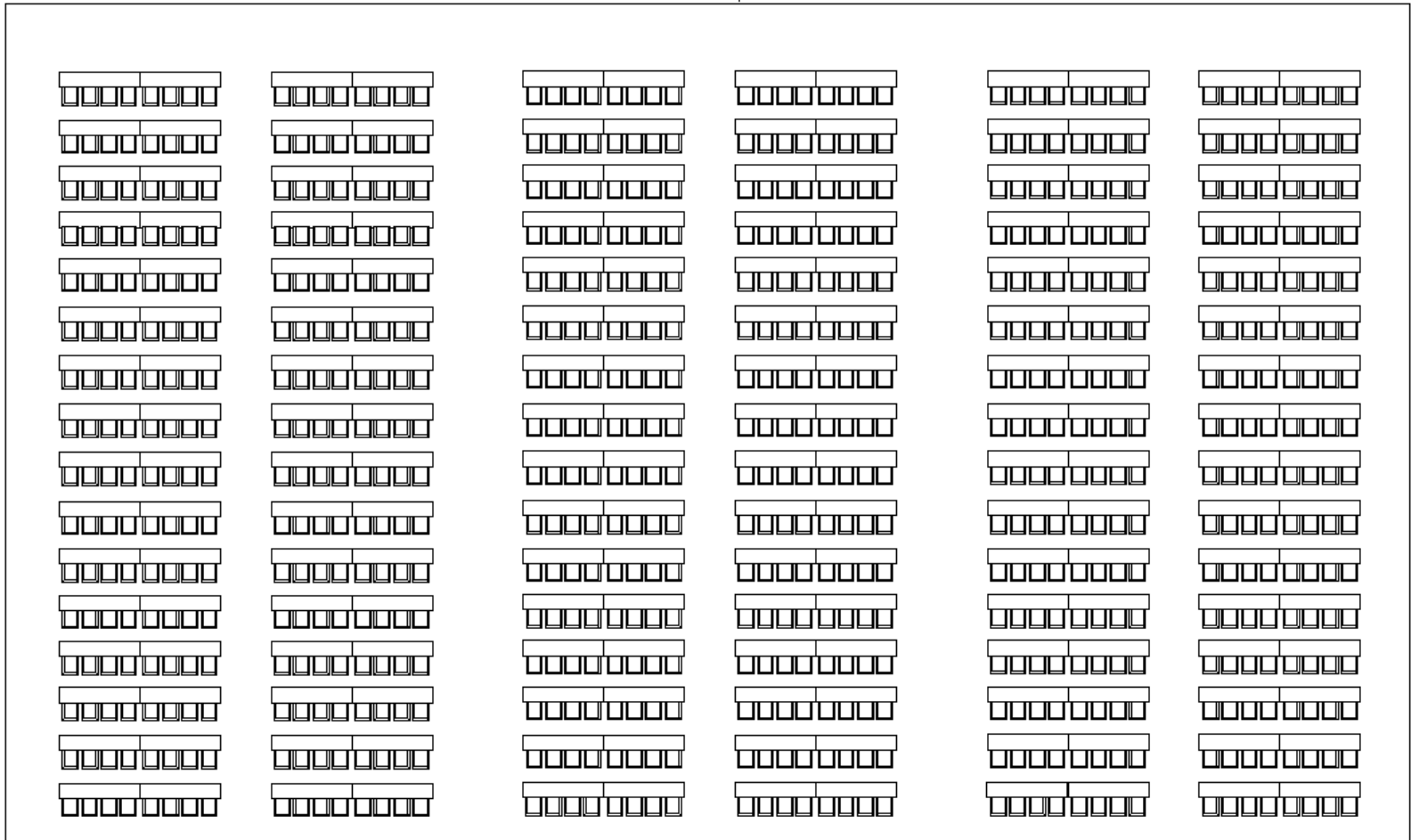

CAPACITY GRID UNICO
"SALONES CENTRAL" 1-3
MAX. BANQUET

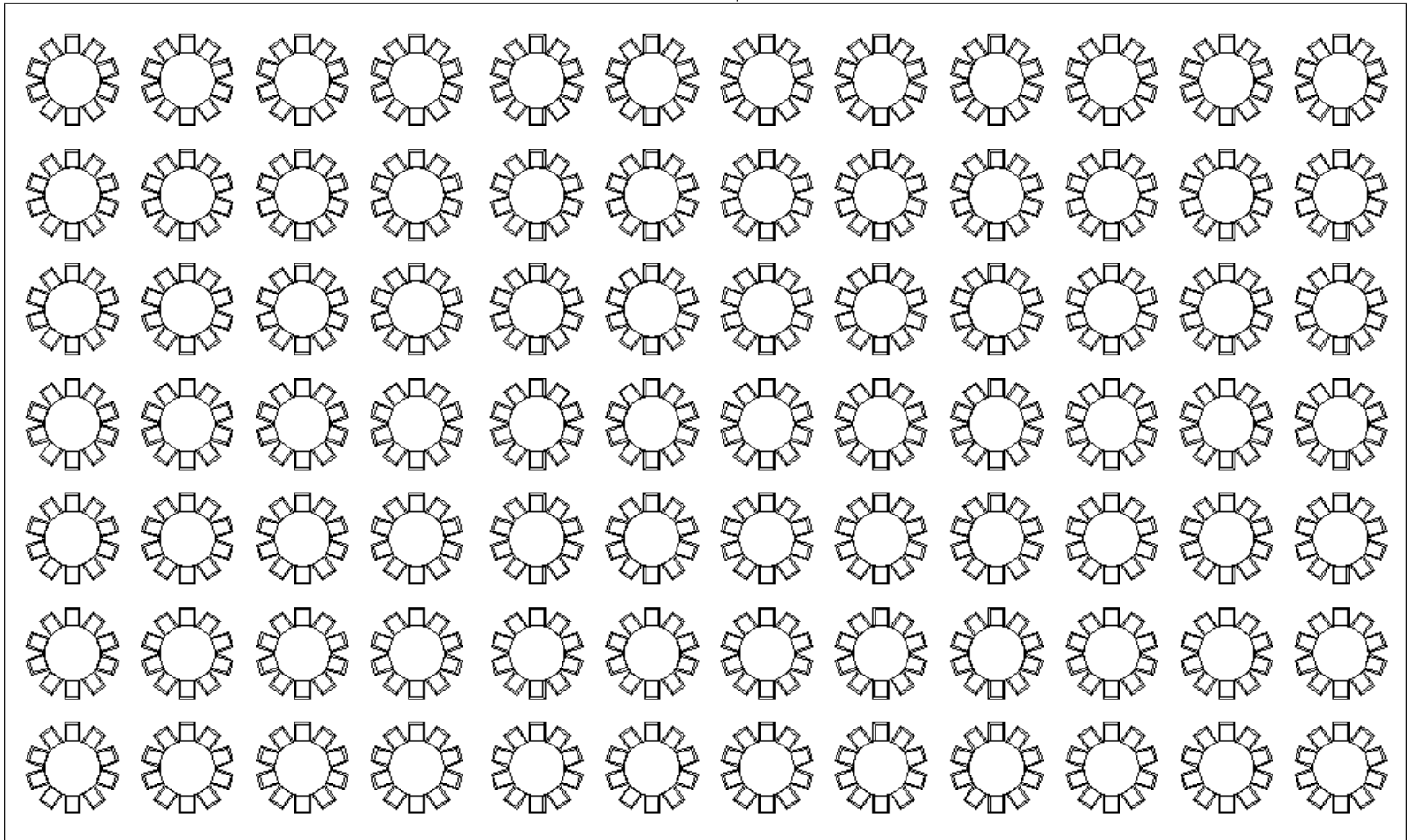

CAPACITY GRID UNICO “CENTRAL” (ONE BALLROOM) MAX. THEATRE

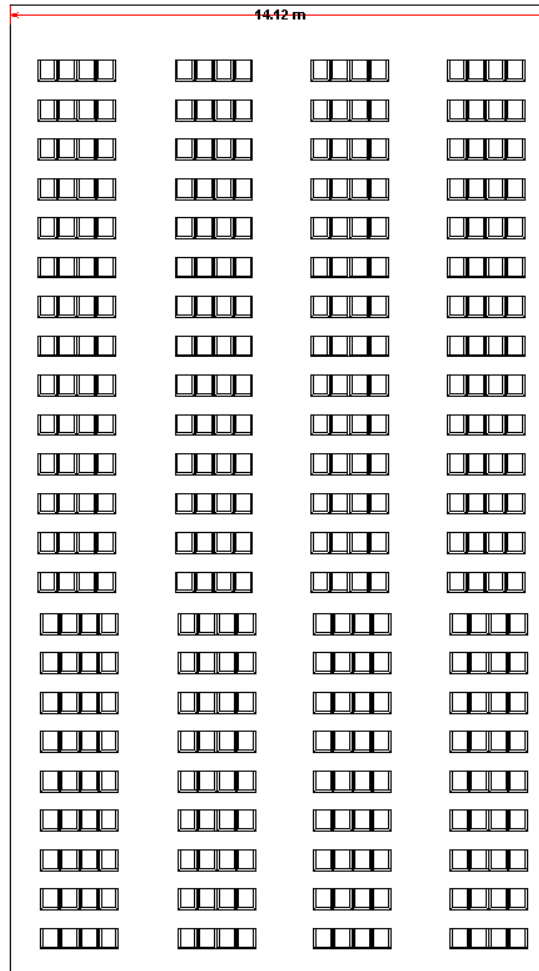

CAPACITY GRID UNICO “CENTRAL” (ONE BALLROOM) MAX. CLASSROOM

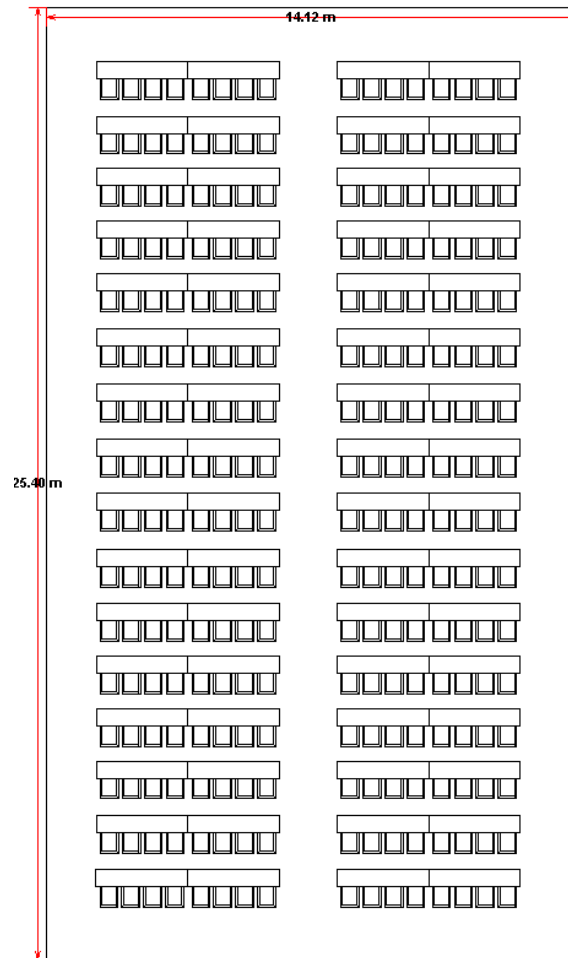

CAPACITY GRID UNICO
“CENTRAL” (ONE BALLROOM)
MAX. BANQUET

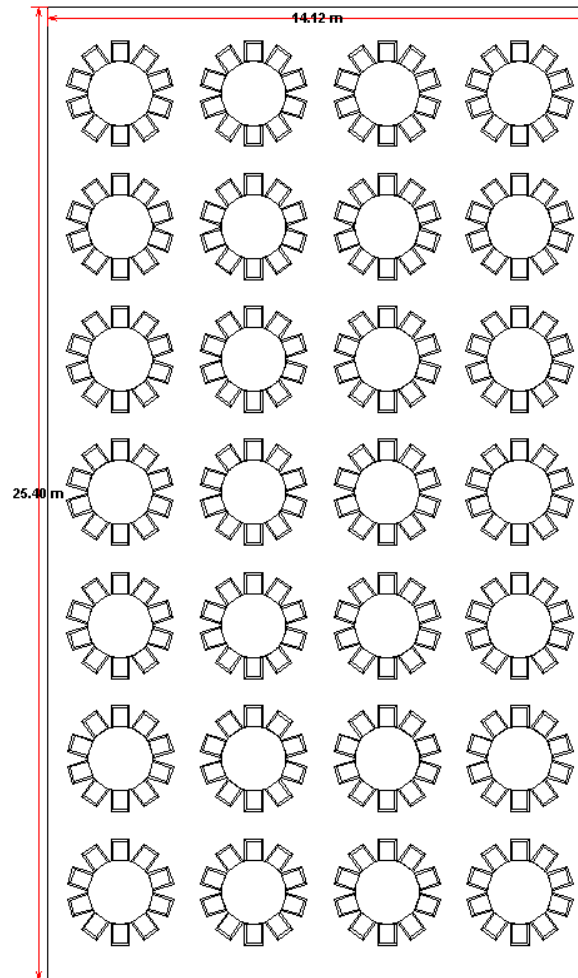

CAPACITY GRID UNICO "SALONES" BALLROOMS



ROOM	DIMENTIONS FT	DIMENTIONS MTS	SQ FT	M2	CEILING FT	CEILING MTS	THEATRE	CONFERENCE	U-SHAPE	BANQUET	COCKTAIL	CLASSROOM
SALONES (1-6)	115,78 X 20,01	35.29 X 6.10	2317,15	215.27	12,14	3.7	220	N/A	N/A	150	220	117
SALONES 1,2,5	15,91 X 20,01	4.85 X 6.10	317,54	29.5	12,14	3.7	30	16	16	20	30	18
SALONES 3,4	24,05 X 20,01	7.33 X 6.10	481,15	44.7	12,14	3.7	45	28	24	30	45	27
SALÓN 6	19,78 X 20,01	6.03 X 6.10	395,9	36.78	12,14	3.7	40	24	20	20	40	24

CAPACITY GRID UNICO
"SALONES" 1-6
MAX. THEATRE

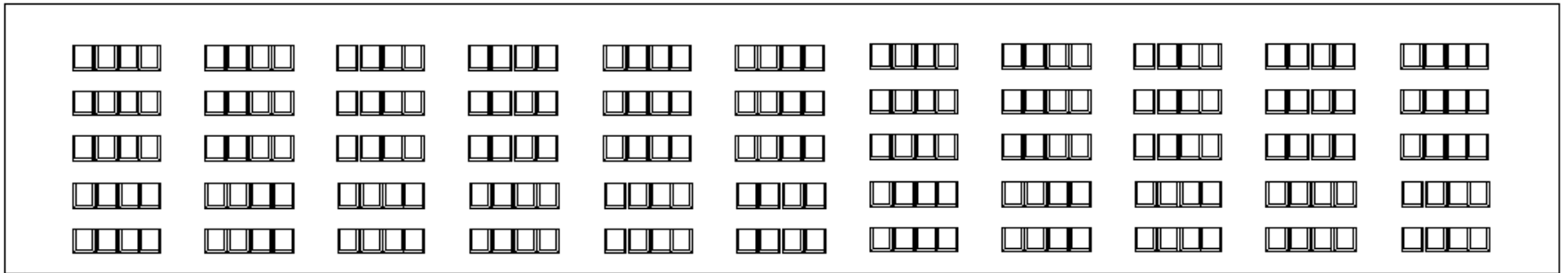

CAPACITY GRID UNICO
"SALONES" 1-6
MAX. CLASSROOM

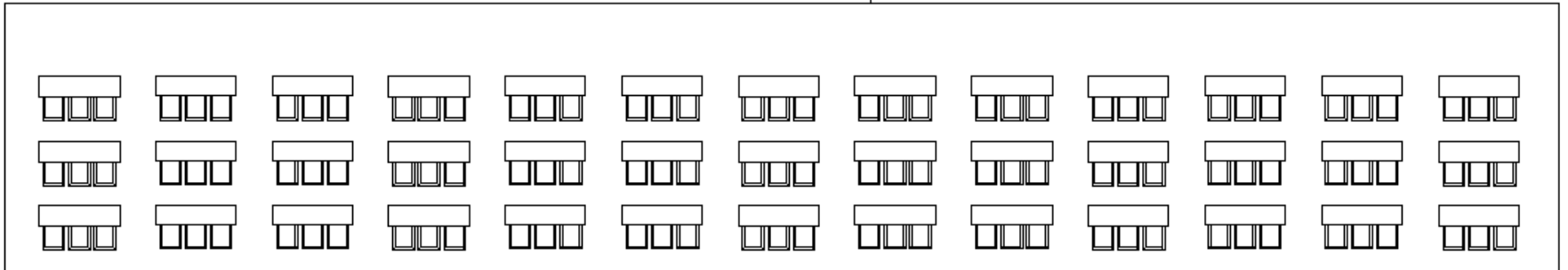

CAPACITY GRID UNICO
"SALONES" 1-6
MAX. BANQUET

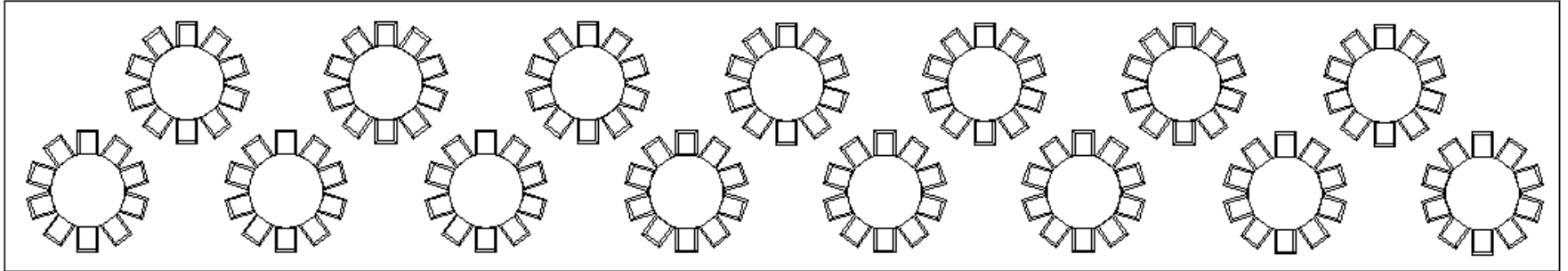

CAPACITY GRID UNICO

“SALONES 1, 2, 3” BALLROOM

MAX. CAPACITY PER SET UP

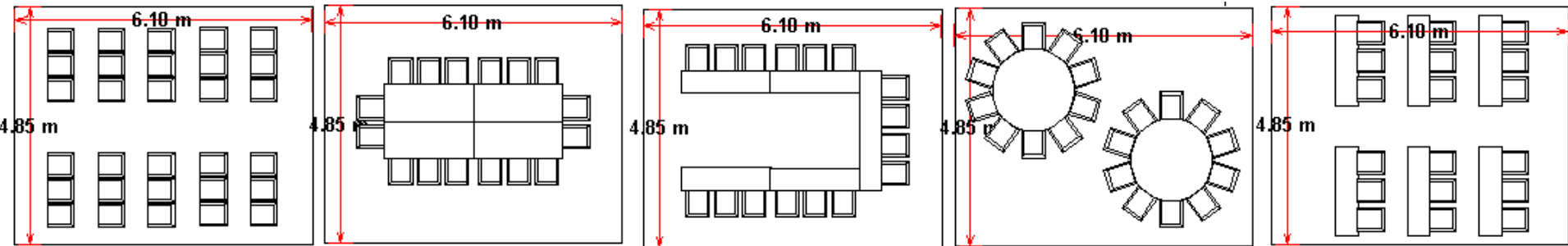

CAPACITY GRID UNICO
"SALONES 3,4" BALLROOM
MAX. CAPACITY PER SET UP

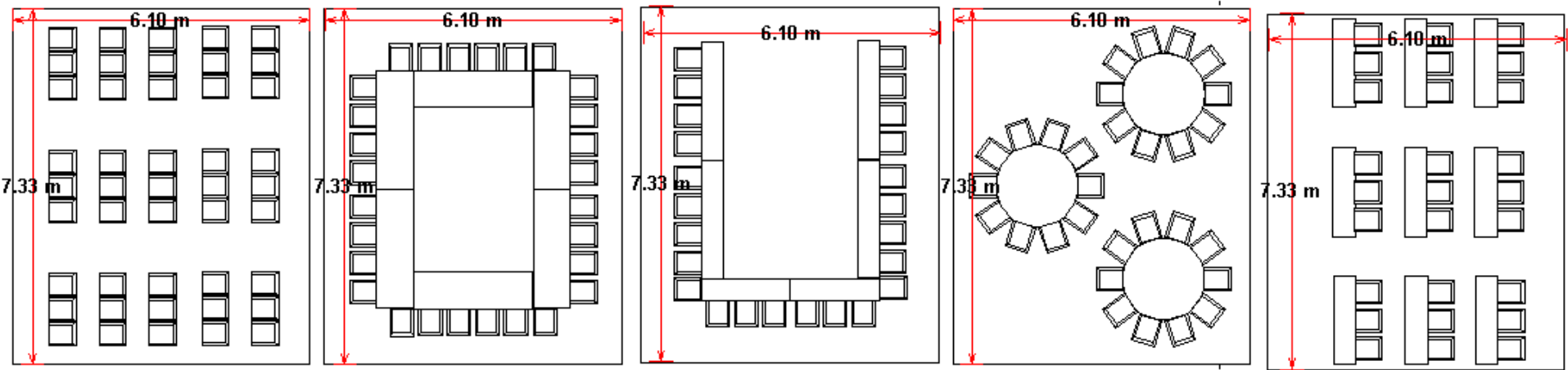

CAPACITY GRID UNICO
"SALONES 6" BALLROOM
MAX. CAPACITY PER SET UP

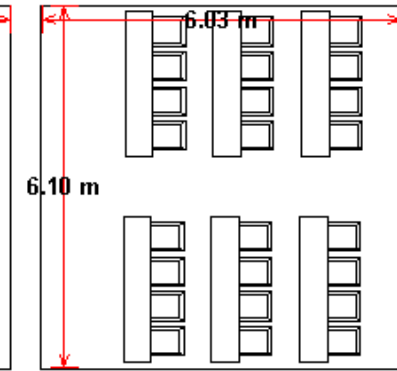
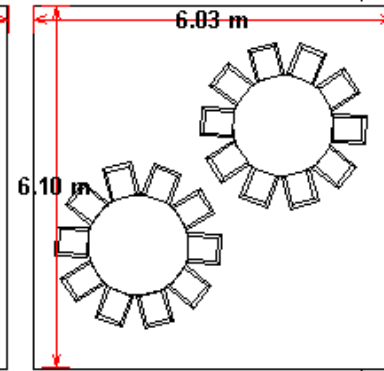
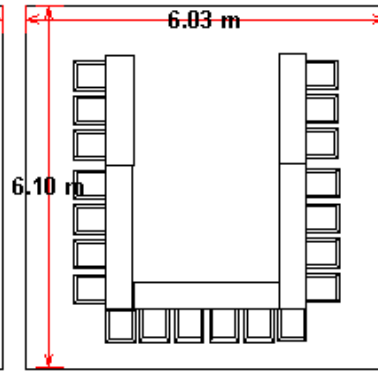
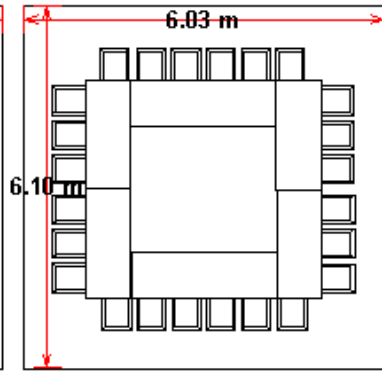
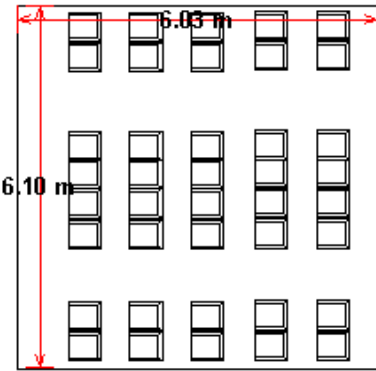

CAPACITY GRID UNICO

“SALONES” & “LIBRERIA” BALLROOMS



ROOM	DIMINTIONS FT	DIMINTIONS MTS	SQ. FT	M2	CEILING FT	CEILING MTS	THEATRE	CONFERENCE	U-SHAPE	BANQUET	COCKTAIL	CLASSROOM
SALONES 7, 8	15,75 X 30,18	4.8 X 9.2	473,61	44	12,14	3.7	48	28	28	30	48	30
LIBRERÍA 1, 2	15,75 X 30,18	4.8 X 9.2	473,61	44	12,14	3.7	N/A	N/A	20	N/A	N/A	N/A

CAPACITY GRID UNICO
"SALONES" (6, 7)
MAX. THEATRE

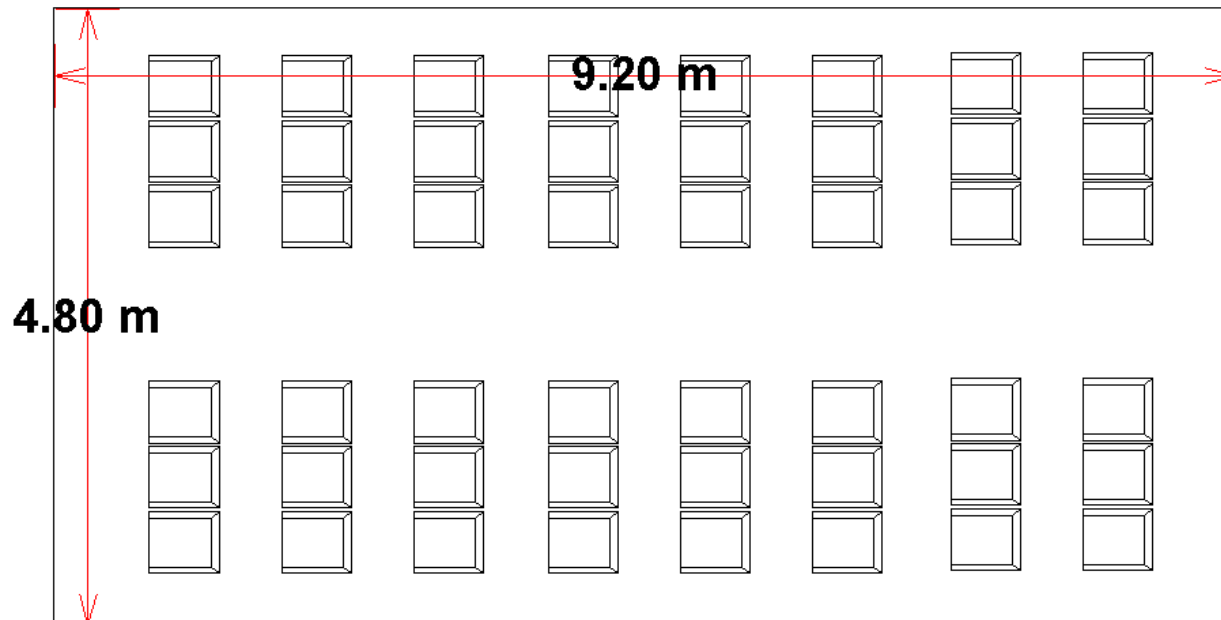

CAPACITY GRID UNICO
"SALONES" (6, 7)
MAX. CONFERENCE

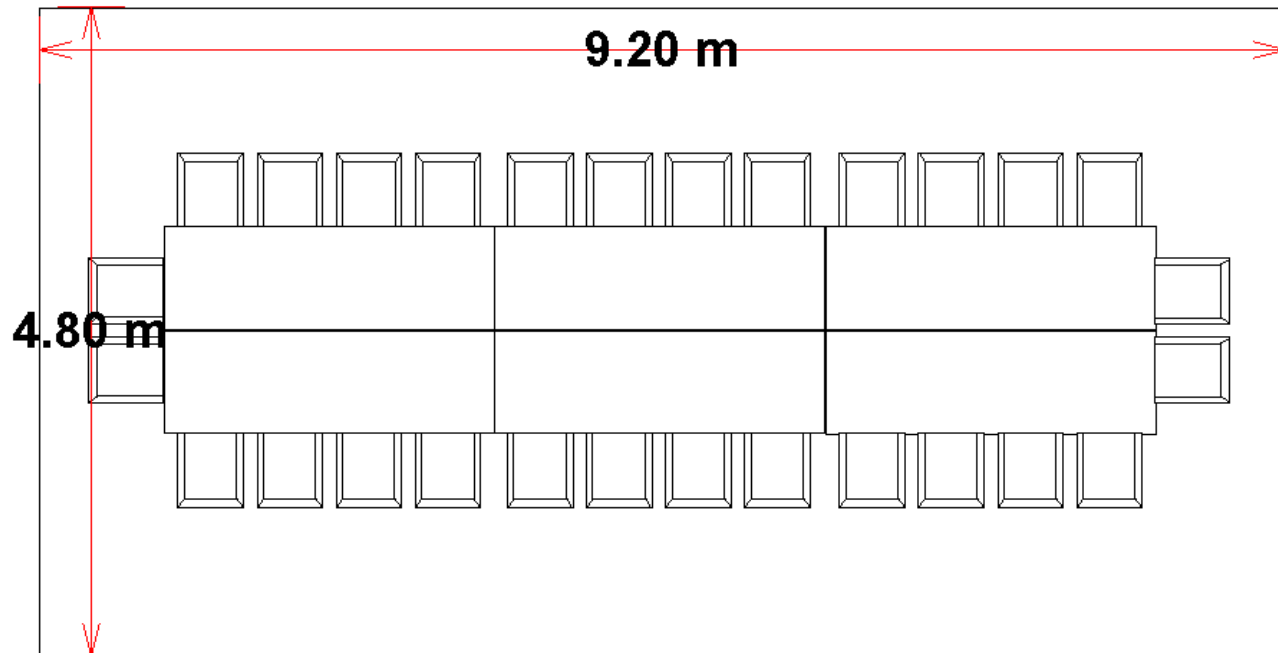

CAPACITY GRID UNICO
"SALONES" (6, 7)
MAX. CLASSROOM

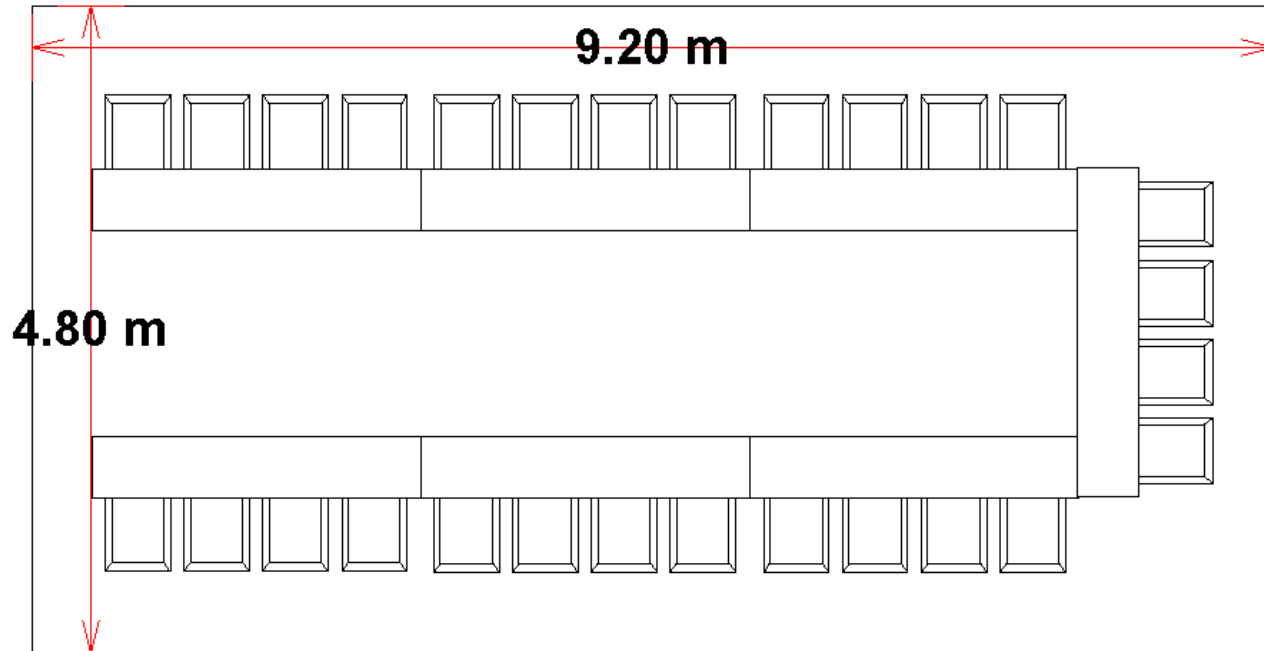

CAPACITY GRID UNICO
"SALONES" (6, 7)
MAX. BANQUET

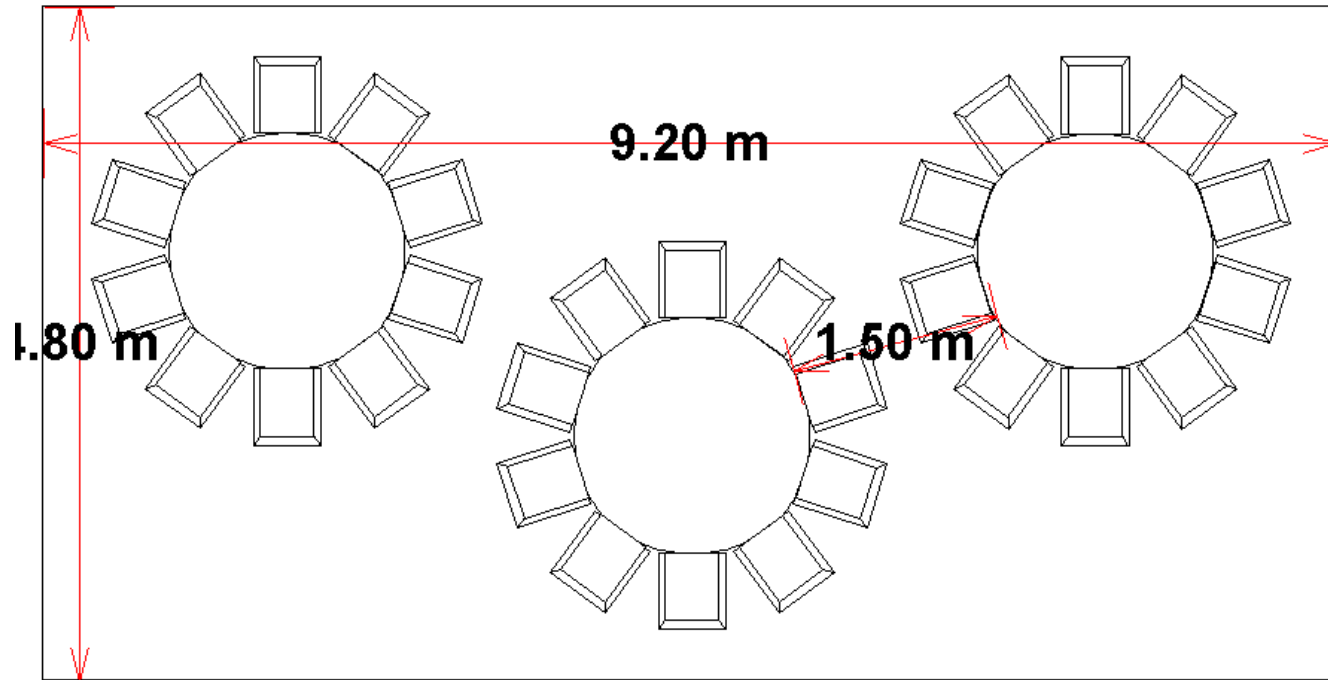

CAPACITY GRID UNICO
"SALONES" (6, 7)
MAX. CLASSROOM

